



Powered Cart *lite*

by Electrodrive









Move loads of up to 300kg safely and efficiently

The Powered Cart Lite is an economical way to move loads that are too heavy or awkward to push by hand. It is very easy to use, with the load positioned in front of the operator, and a simple twist grip control to vary the trolley's speed. A flat bed allows for a variety of load shapes and sizes, including the optional fitting of cages or shelving to suit your needs.

The Powered Cart Lite takes the proven design of our Powered Trolley, and makes it available for lighter loads at a reduced price.

Typical applications include:

- Transport of books and journals (popular in libraries and legal firms)
- Archiving and document transport (purpose cage attachment available)
- Moving boxes and parts

-  Capacity: 300kg
-  Economical solution for moving heavy or awkward objects
-  Reduce workplace strain and injury
-  Quiet, smooth operation with zero emissions
-  Non-marking tyres suitable for indoor use
-  Simple variable speed control, no driver's licence required
-  Comprehensive 12 month warranty on all Electrodrive equipment





Powered Cart *lite*

by Electrodrive

Standard Unit

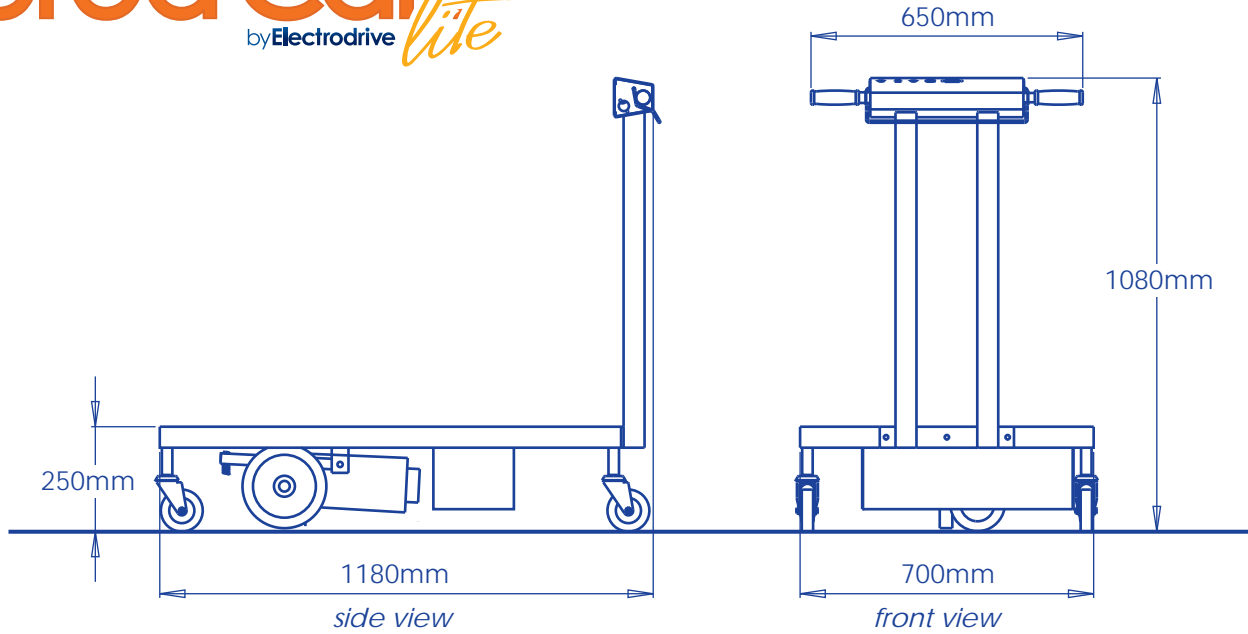

Specifications

	Powered Cart Lite:
Height:	1080mm
Length:	1180mm
Width:	700mm
Load Ht.	250mm
Capacity:	300kg
Weight:	80kg
Voltage:	24V
Range:	~6km

Controls

